





LUCI SERIES EOS² INDUSTRY

Benefits

- Flexible luminaire. Select the number of LED's and optic for an ideal lighting solution.
- Easy Installation. Click & Lock surface mounting plate.
- Intelligent output control using integrated Motion and Daylight sensor.
- Self-controlled operating conditions:
 - Luminaire Intelligent Protection System (LIPS). 
 - Active Overheat Protection (AOP). 
 - Light Normalizer – No Lumen drop during lifetime.
- Integrated EOS technology: 
 - Plug-and-play self-organizing wireless network.
 - Encrypted communication.
 - Advised maximum spacing for network: 25 meter.
- Intuitive control and analysis with the EOS Manager app:
 - User authentication and data encryption.
 - Visual representation of your network.
 - Extensive configuration, information, and usage statistics.
 - Share sensor information between EOS devices.
- Protected against dust and water intrusions.

Features

Lumen Output	Up to 19.617 lm
Input Power	Up to 180 W
Efficacy	Up to 127 lm/W
Colour Temperature (CCT)	4000K / 5700K
Colour Rendering Index (CRI)	83+ / 73+
Rated Life	100.000+ Hours*
Daylight Sensor (DLS)	Integrated
Motion Sensor (PIR)	Integrated. Range: 7 meter**
Housing	PC-ABS white, Anodized Aluminium
Optic	PMMA
Mounting Options	Surface, Recessed
Dimensions	326 x 326 x 98 mm
Operating Temperature	-30 °C to +60 °C***
Connection cable	1500 mm EPR extra flexibility (-40 °C + 90 °C), UV resistant
Ingress Protection	IP67
Voltage	90 - 305 VAC @ 47 - 63 Hz 127 - 431 VDC
Inrush current	65 A 1,2 ms
B-16A fuse	10 pcs
C-16A fuse	14 pcs
Rated Input Current	120 V - 1.25 A 305 V - 0.54 A
Power Factor	0.97 typical
IEC Safety Class	I
Weight	7.2 kg
AC Harmonics	Less than 10% THD compliant to EN55015

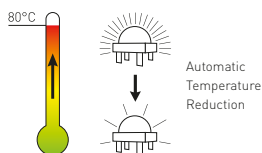

* L80/B10 at 25 °C constant ambient temperature, constant full power.
 ** Detected temperature difference 8 °C @ 1 m/s
 *** Active Overheat Protection above 80 °C at PCB 



DIMENSIONS

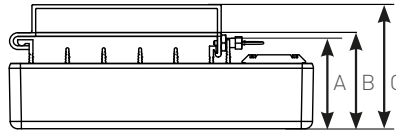
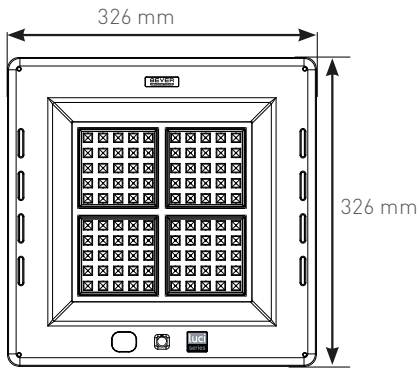

- A recessed* = 98 mm
- B surface mounted = 103 mm (low profile)
- C surface mounted = 133 mm (standard profile)

* Optional recessed brackets available.

ORDERING INFORMATION

Article number	Nomenclature	Number of LED's	Optic	Default Power	Default Lumen	Max. Power	Max. Lumen	Max. Efficacy	CCT	CRI
Luci Series EOS 40 LED										
16759	Luci02-S-MB01-40LED-N0-93W (EOS ² , 5700K)	40	Symmetrical	75 W	8645 lm	93W	10382 lm	127 lm/W	5700K	73+
Luci Series EOS 50 LED										
16764	Luci02-S-MB01-50LED-N0-125W (EOS ² , 4000K)	50	Symmetrical	102 W	11155 lm	125 W	13300 lm	117 lm/W	4000K	83+
16760	Luci02-S-MB01-50LED-N0-125W (EOS ² , 5700K)	50	Symmetrical	102 W	11552 lm	125 W	13626 lm	125 lm/W	5700K	73+
16868	Luci02-A-MB02-50LED-N0-125W (EOS ² , 4000K)	50	Asymmetrical	102 W	11279 lm	125 W	13309 lm	116 lm/W	4000K	83+
16762	Luci02-A-MB02-50LED-N0-125W (EOS ² , 5700K)	50	Asymmetrical	102 W	11691 lm	125 W	13790 lm	123 lm/W	5700K	73+
Luci Series EOS 80 LED										
16765	Luci02-S-MB01-80LED-N0-180W (EOS ² , 4000K)	80	Symmetrical	145 W	15636 lm	180 W	18790 lm	120 lm/W	4000K	83+
16761	Luci02-S-MB01-80LED-N0-180W (EOS ² , 5700K)	80	Symmetrical	145 W	16358 lm	180 W	19496 lm	127 lm/W	5700K	73+
16766	Luci02-A-MB02-80LED-N0-180W (EOS ² , 4000K)	80	Asymmetrical	145 W	16074 lm	180 W	19240 lm	119 lm/W	4000K	83+
16763	Luci02-A-MB02-80LED-N0-180W (EOS ² , 5700K)	80	Asymmetrical	145 W	16341 lm	180 W	19617 lm	121 lm/W	5700K	73+

OPTICS

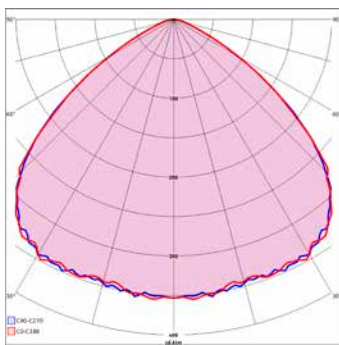

Symmetrical

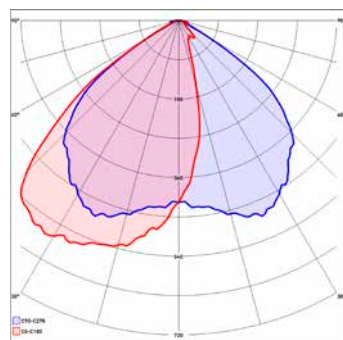

Asymmetrical

OPERATING TEMPERATURE VS MAXIMUM OUTPUT%

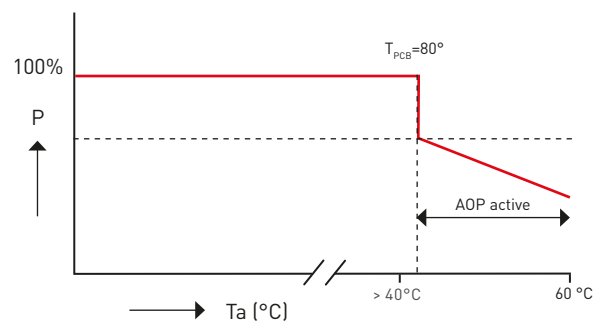

ACCESSOIRES

Surface Mounted

- 13135 High Mounting plate for Surface mounting
- 12996 Low Mounting plate for Surface mounting

Recessed Mounted

- 13406 Recessed frame for new canopies and retrofit of Philips Mini 300 (hole 360x360 mm)
- 11726 Recessed frame for retrofit of Philips MPF (hole 470x470 mm)
- 13742 Recessed frame for retrofit of Cube (hole 380x380 mm)
- 13746 Recessed frame for retrofit (hole 600x600 mm)
- 13738 Recessed frame for retrofit of Parkersell Canolux (hole 560x410 mm)

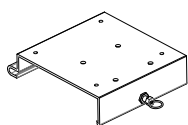

13135 Luci Series + High Mounting Plate = 133 mm high

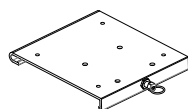

12996 Luci Series + Low Mounting Plate = 103 mm high

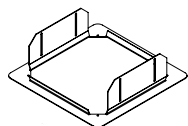

13406 Philips Mini 300 (hole 360x360 mm)

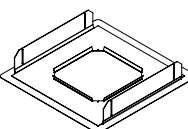

11726 Philips MPF (hole 470x470 mm)

13742 Cube (hole 380x380 mm)

13746 Retrofit (hole 600x600 mm)

13738 Parkersell Canolux (hole 560x410 mm)

COMPLIANCES LUCI SERIES EOS

IEC 60598-1	Luminaire - Part 1: General requirements and tests
IEC 60598-2-1	Luminaire - Part 2-1: Particular requirements - Fixed general purpose luminaires
IEC 60598-2-2	Luminaire - Part 2-2: Particular requirements - Recessed luminaires
IEC 62471:2008	Photobiological safety of lamps and lamp systems
EMC directive 2014/130/EU:	
- EN 55015:2006 +A1:2007, +A2:2009	Limits and methods of measurement of radio disturbance of electrical lighting and similar equipment
- EN 61000-3-2:2006 +A1:2009, +A2:2009	Harmonic current emissions
- EN 61000-3-3:2008	Limitation of voltage fluctuations
- EN 61547:2009	Equipment for general lighting purposes. EMC immunity requirements. From which:
o EN 61000-4-2:2009	Electrostatic discharge (ESD) immunity
o EN 61000-4-3:2006 +A1:2008, +A2:2010	Radiated EM field immunity
o EN 61000-4-4:2004, +A1:2010	Electrical fast transient (EFT) immunity
o EN 61000-4-5:2006	Surge transient immunity
o EN 61000-4-6:2009	Conducted Radio-frequency disturbance immunity
o EN 61000-4-11:2004	Immunity to voltage dips and short interrupts.
- ETSI EN 300 328 V1.9.1	Wideband transmission systems; Data transmission equipment operating in the 2,4 GHz ISM band and using wide band modulation techniques

All product, product specifications and data are subject to change without notice to improve reliability, function, design or otherwise. Photos and pictures are for illustration purpose only.

Reveb_SPEC_LUCI SERIES EOS² INDUSTRY_GB_2018-07-11